

MARK

REVISED CONTENT

DATE

APPROVED

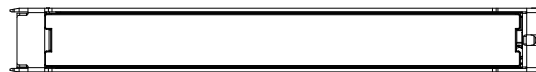
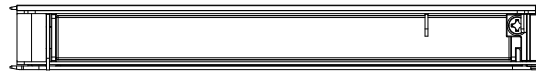
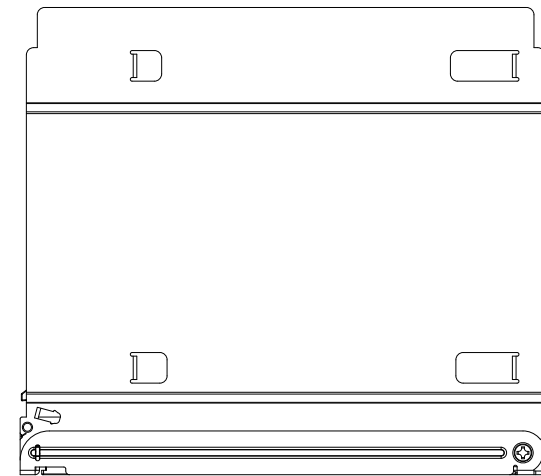
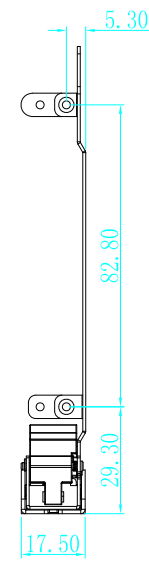
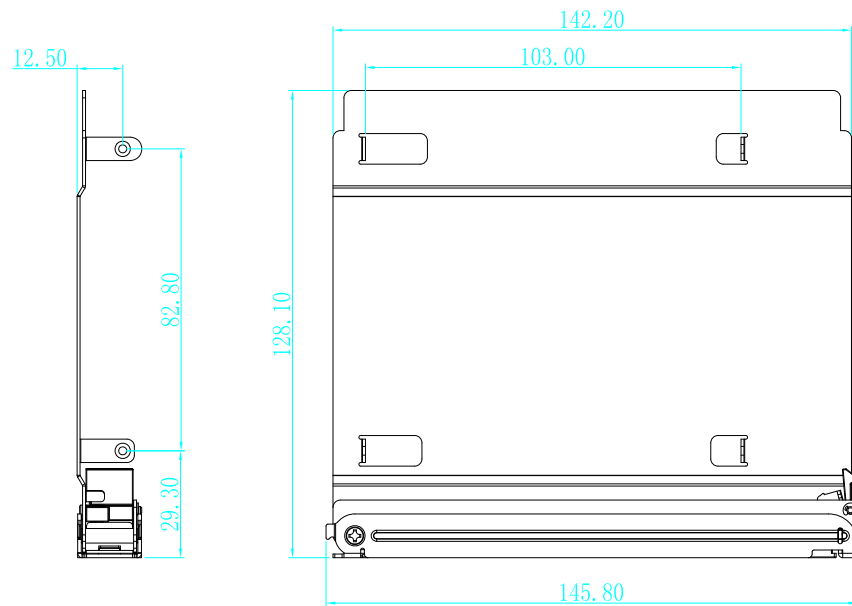
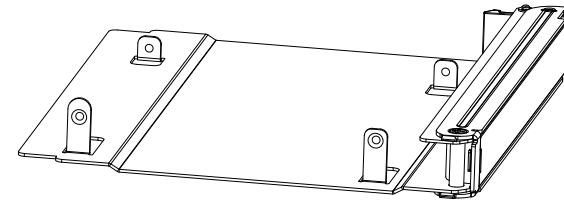

CREMAX TECH CO., LTD.

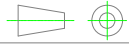
TITLE				TOLERANCE	
MB9940T-B 组立图		MATERIAL		X	±0.20
				X.X	±0.10
				X.XX	±0.05
				X°.X"	±0.5"
DRAWN	DATE	FINISHED		SCALE	
				1:1	
CHECKED	DATE	PART NO.		UNIT	REV.
				mm	
APPROVED	DATE	DWG. NO.		SHEET 1 OF 1	

APPLIED MODEL